

technical hotline +44 (0)1268 563720

screeded floor systems

Cablelink Plus Screed System

Cablelink Plus Screed System provides adaptable power and data distribution highways in screeded floors.

- Tested to pr EN50085-2-2 to accept 5000N load
- The system incorporates numerous design features to ensure a fast and simple installation
- Designed to support Cat 6 structured cabling systems
- Suitable for screeded depth from 53mm to 110mm
- Floorboxes are IP2X rated in accordance with BS EN50085-1
- Choice of 1, 2, 3 or 4 compartment floorboxes
- Self Closing lid in accordance with draft IEC 61534-22
- Wide range of power and data accessories available to meet all requirements
- PVCu ducting manufactured from 100% recycled material
- Quality, reliability and safety come as standard
- Provision of RCD protection supports compliance with the 17th Edition Wiring Regulations
- 5 year guarantee

Top tips

- Distance between two junction boxes must not exceed 6 metres
- Carpets – use those with backing at least 2mm thick
- Service Outlet Boxes – fixed only on branch ducts and not on header ducts. Fixing service boxes on the header ducts affects cable capacity and constricts the header
- Workstations – locate over Service Outlet Boxes so that it does not interfere with normal office traffic

Layout

In order that the installation may exhibit the desired flexibility, the ducting is usually laid out on either a Grid, Fishbone or a Comb Pattern of single, double or triple runs.

A **Grid Pattern** is widely used in areas where the occupants require the highest degree of flexibility in reorganising work areas. Capacity can be increased by returning individual ring mains through different runs of duct / trunking, which in itself allows easier installation.

The **Fishbone Pattern** is ideal for a medium sized area where lesser boxes are required.

The **Comb Pattern** is the most economical way of installation where least duct / trunking is used. The comb pattern is suited for medium to small office areas.

Standards

Cablelink Plus Screed System range complies with the relevant requirements of the latest edition of IEE Wiring Regulations (BS 7671) and to BS EN50085 Part 1 and draft EN50085 Part 2-2. Additionally the floorboxes also comply with IEC 60670 Parts 1 and 23. The metal used complies to the requirements of BS EN10327: 2004.

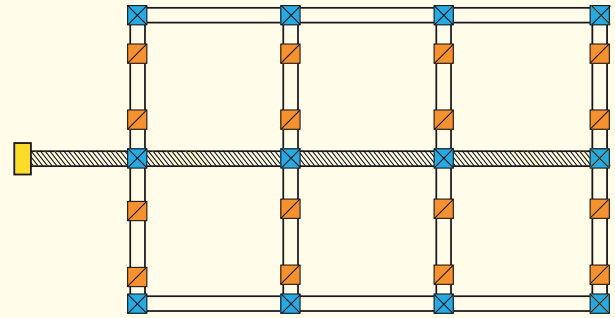

Grid pattern

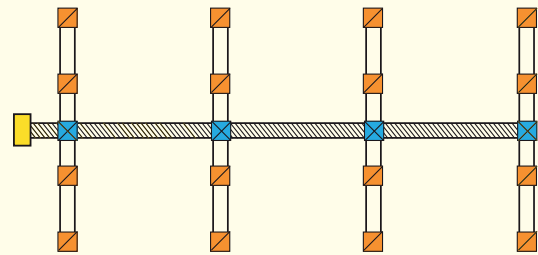

Fishbone pattern

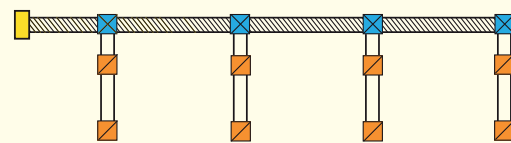

Comb pattern

- | | |
|---------------------|------------------------|
| Header Runs | Universal Junction Box |
| Service Outlet Box | End Cap |
| Vertical Access Box | Branch Runs |

Cablelink Plus Screed System

Cable Capacity Guide

The tables below are computed on a theoretical calculation based on the 16th Edition* of the IEE Wiring Regulations and must be regarded only as a guideline. Care should be taken in selecting adequate trunking sections taking into consideration the number and size of cables involved and construction of the junction box. It is recommended that the initial design of trunking installations include adequate provision for future wiring. To determine the size of the trunking required, multiply the quantities of each size of conductor and appropriate factor from Table A and compare the total with the capacity unit figure in the appropriate Table B.

Table A - Cable Factors		
Cable Type	CSA	Cable Factor
Power Cables		
PVC Stranded	1.5mm ²	8.6
	2.5mm ²	12.6
	4mm ²	16.6
	6mm ²	21.2
	10mm ²	35.3
	16mm ²	47.8
Twin & Earth	2.5mm ²	86
	4mm ²	99
	6mm ²	148
Data Cables		
Cat 5E UTP	5.5mm dia	30.2
Cat 5E STP	6.0mm dia	36
Cat 6 UTP	6.5mm dia	42.2
Cat 6 STP	7.0mm dia	49

Sample calculation

To estimate the total number of cables that can be accommodated with a 100 x 38mm ducting:

Step 1 Pick the factor from Table B corresponding to 100 x 38 = 1563

Step 2 Select the size of the cable that needs to be pulled through the trunking and its corresponding factor from Table A
e.g. 4mm² stranded = 16.6

Step 3 No. of cables = Value from (Table B / Table A)
e.g. 1563/16.6 = 94 Nos.

Top tips

- The number and location of boxes will depend on the end user requirements
- If the furniture layout is available, a floor box should be considered for each workstation or desk
- If the final furniture layout is not available as a general guide the minimum recommended distribution is one floor box for every 10m², and the maximum being one floor box per 4m²

TABLE B – Metal Screed Ducting Cabling Capacity			
Size (mm)	Compartment size	Capacity 100%	Capacity (45% fill)
100x25	100x25 (1 comp)	2205	992
100x38	100x38 (1 comp)	3474	1563
225x25	112x25 (2 comp)	2501	1125
	75x25 (3 comp)	1658	746
225x38	112x25 (2 comp)	3940	1773
	75x38 (3 comp)	2613	1176
250x25	83x38 (3 comp)	1847	831
250x38	13x38 (3 comp)	2909	1309
275x25	137x25 (2 comp)	3066	1380
	91x25 (3 comp)	2035	916
275x38	91x38 (3 comp)	3206	1443
300x25	100x25 (3 comp)	2223	1000
300x38	100x38 (3 comp)	3503	1576

Cablelink Plus Screed System ducting complies with BS EN50085-1: 2005 and draft EN50085 Part 2-2.

The above table gives the available capacity units on 45% factor, applied to the internal wiring area.

Carpet Cut out Dimensions

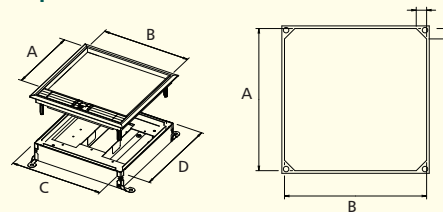

The table below shows the sizes required for the carpet lid infill and carpet tile cut out for the Cablelink Plus Screed Floorboxes.

LID LIST NUMBER	CARPET LID INFILL DIMENSIONS (mm)		BASE LIST NUMBER	BOX CARPET CUT OUT DIMENSIONS (mm)	
	A	B		C	D
CXL100	152	93	CUB100	100	100
CXL200	152	185	CUB200	200	200
CXL265	219	251	CUB265	265	265
CXL340	219	326	CUB340	340	340
CUJL200	188	188	CUJ200	200	200
CUJL265	253	253	CUJ265	265	265
CUJL240	328	328	CUJ240	340	340

Where A is from left to right and B is from back to front.

*At the time of going to print, the IEE had yet to publish the 17th Edition Wiring Regulations Guidance Notes and On-site Guide.

technical hotline +44 (0)1268 563720

screeded floor systems

Cablelink Plus Screed System

Cablelink Plus Screeded Service Box

- Materials** UL94 V2 rated nylon, Pre-galvanised steel.
- Strength** The floor outlet boxes are capable of resisting minor accidental loading when rigidly supported under the outer rim of the cover frame.
- Fire** The outer casing of the floor outlet box is manufactured from metal and is non-combustible. The 8mm recess frame and lid assembly is made from UL94 V2 rated nylon the 12mm recess frame and lid assembly is manufactured from metal and is non corrosive.
- Chemical resistance** Non corrosive.
- Water absorption** The floor outlet boxes are for use in situations where the cleaning method used does not result in the formation of pools of liquid or soaking of the floor surface.
- Degree of protection** Enclosure classification of IP2X when installed in accordance with the instructions set out in the installation guide.

Ambient Temperature Range

	Minimum	Maximum
Handling and storage	-5°C	60°C
During installation	-5°C	60°C
Operating	-5°C	40°C

Average not to exceed 35°C in any 24 hour period.

RAL Colours

Grey (GRY) = RAL 7011
Light Grey (LGY) = RAL 7046

PVCu Ducting and Accessories:

- Manufacture** Duct straight lengths are extruded from 100% recycled PVCu. Fittings are formed by injection moulding.
- Appearance** All PVCu duct and accessories are normally smooth, matt white finish.
- Strength** Heavy gauge, medium impact resistance under normal conditions.
- Fire** Non flame propagating. Class 1 spread of flame.
- Chemical resistance** Non-corrosive and not affected by sea water. Excellent resistance to mineral acids, alkalis and detergents but liable to attack from solvents such as alcohol, ketones, aromatics and hydrocarbons.
- Vermin** Resistant to vermin and termites.
- Thermal** Lower and upper limit of range of ambient temperature from -25°C to 60°C. All products are designed to accommodate local thermal expansion and fitting instructions cover differential movement at the interface with the building fabric. Thermal expansion co-efficient: $5.5 \times 10^{-5}/^{\circ}\text{C}$.
- Electrical** Duct is non-conductive.
Dielectric strength: 40kV/mm in DBP
17kV/mm in tx oil.
Volume resistivity: $>1014 \Omega\text{cm}$.
- Durability** The product is stable within the terms and conditions described above and will maintain its performance characteristics.
- Workability** The duct is light weight and can be readily cut with hand tools. Short lengths can be readily incorporated and there is low wastage of material. Components and joints can be solvent welded together where necessary.

Metal Duct and Accessories:

- Material** Pre-galvanised sheet steel.
- Standard thickness** 1.2mm. Standard 1mm available on request.
- Standard length** 2.44 metres.
- No. of compartments** 1, 2 or 3 compartments.
- Standard depth** 25mm and 38mm (Different depths are available on request).

Couplers have to be ordered separately.

Pre-cut lengths can be arranged, subject to price confirmation and availability.

Cablelink Plus Screed System

Installation Guide for Underfloor Duct System

The structural floor slabs on which the underfloor ducts and boxes are to be laid must be reasonably level and smooth. Humps and protruding cement must be hacked to level to ensure the ducts being laid will maintain the minimum screed thickness of 25mm over the ducts. It is recommended that a layer of green screed be laid on the structural slab beneath the underfloor ducts to prevent air gaps and vacuum while screeding.

① The floor slab where junction and service outlet boxes are to be laid should be marked out. The appropriate duct entry plates should be fastened to the boxes.

Ducts should be laid in straight lines between points of junction boxes and parallel to known base lines on each floor. Changes in direction of ducts should be made with junction boxes.

Use steel fixing clips to secure the ducts on to the floor slab prior to screeding. The intervals between two saddles should not exceed a maximum of 2 metres.

All joints in ducts and terminations of ducts in junction boxes / vertical access boxes should be made water tight with approved type sealing compound. Precaution should be exercised during construction to prevent damage to the ducts system and to ensure that the ducts and vertical boxes are free of water, dirt, debris or any other obstruction which may impede and / or damage the cables during pulling in.

② Junction and service outlet boxes should be properly covered with the disposable lids and taped to ensure no cement gets into the boxes during screeding.

After screeding the disposable screed cover is removed and the cable installation can begin.

③ If extra space is required under the accessory mounting tray then height adjuster kits can be used. The cables can now be installed and the services terminated.

Note: The bases are supplied with 35mm wiring space, with the option to reduce to 25mm or increase to 45mm with a height adjustment kit – part number CUBA-1 or CUBA-2, see page 61

④ The frame and lid assembly can now be fitted. Ensure the ratchet release is set to the lock position and align these with the ratchets in the accessory tray.

⑤ Apply gentle pressure until the frame is securely seated in the box and against the finished floor e.g. carpet or vinyl.

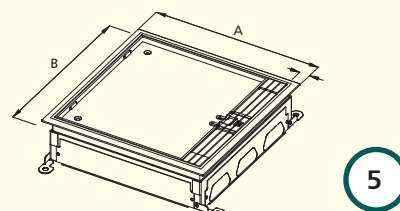
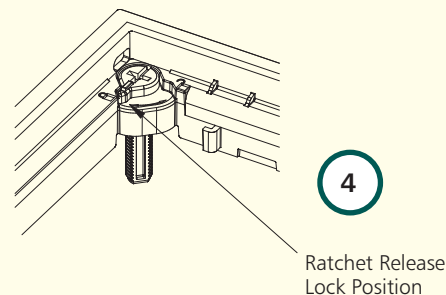
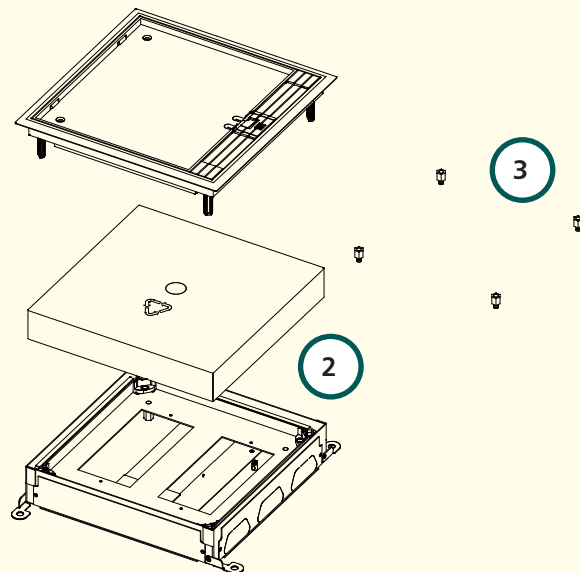
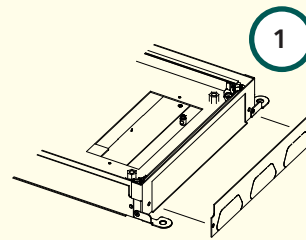

technical hotline +44 (0)1268 563720

screeded floor systems

Cablelink Plus Screed System

⑥ If the frame and lid assembly requires to be removed or rotated to ease cable egress then the ratchet releases should be rotated to the unlock position and the frame can be lifted out of the floorbox. The assembly can then be rotated and fixed as before.

Note: The lid should be completely removed from the frame before attempting to release the frame.

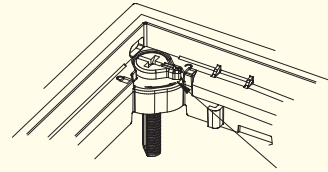

Ratchet Release
Unlock Position

⑦ Attention must be paid to ensure there is both sufficient wiring depth and plug top clearance for the particular cables / plugs being used in each installation.

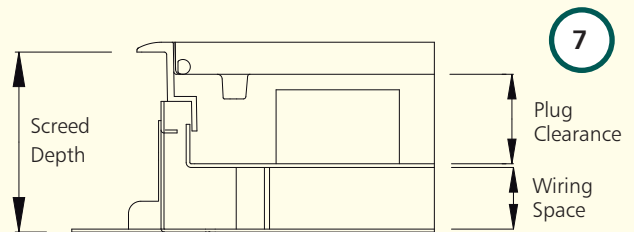

Screed Depth – 25mm, 35mm and 45mm Wiring Space

This graph enables the specifier / installer to determine which depth the screed must be in order to achieve a certain accessory wiring space and plug top clearance within the floorbox. For example if the specifier requires a 35mm standard wiring depth and a 45mm plug top clearance then the graph shows that an 82mm screed depth is required. Alternatively, if the screed depth is fixed, at 90mm for example, then by having a 45mm wiring space the resulting plug top clearance will be 43mm. If additional plug top clearance is required then the wiring depth can be reduced to 35mm or even 25mm providing a plug top clearance of 53mm or 63mm respectively. Care must be taken to ensure there is sufficient wiring depth and plug top clearance for each individual installation.

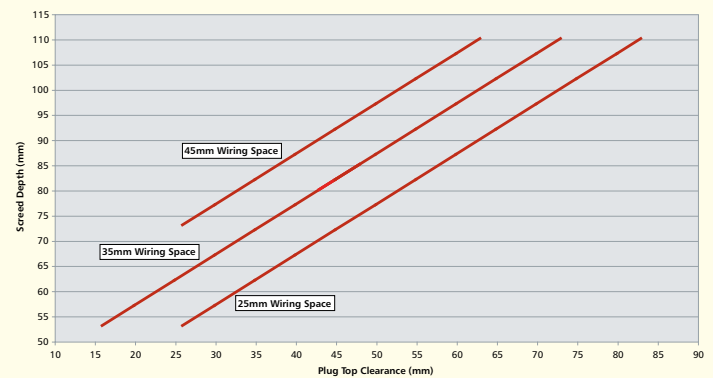

Vertical Access Boxes: Metal Ducting

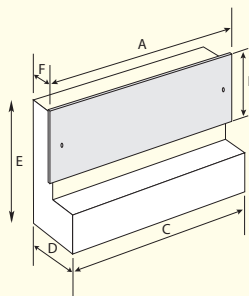

List Number	To Suit Box	Cover Plate Dims	
		A (mm)	B (mm)
Flush Cover Plate (supplied a standard)			
n/a	CUV265	265	90
n/a	CUV340	340	90
Overlapping Cover Plate			
CUVP265	CUV265	285	100
CUVP340	CUV340	360	100

List Number	Box Dimensions (mm)			
	C	D	E	F
CUV265	265	85	50	200
CUV340	340	85	50	200

Vertical Access Boxes: PVC Ducting

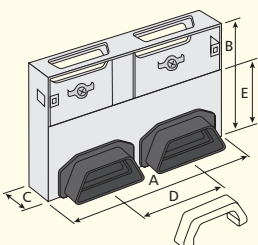

List Number	Type	Dimensions in mm		List Number	Type	Dimensions in mm	
		A	B			A	B
Overlapping Shallow				Flush Shallow			
SF88180	Twin	280	80	SF88176	Twin	260	70
SF88181	Triple	390	80	SF88177	Triple	370	70
Overlapping Full Access				Flush Full Access			
SF88188	Twin	280	180	SF88184	Twin	260	170
SF88189	Triple	390	180	SF88185	Triple	370	170

List Number	Type	Dimensions in mm				
		A	B	C	D	E
Shallow						
SF88152	Twin	260	170	50	110	100
SF88153	Triple	370	170	50	110	100
Full Access						
SF88172	Twin	260	270	50	110	100
SF88173	Triple	370	270	50	110	100

Cablelink Plus Screed System

Load Testing

Load Testing of Floorboxes to draft pr EN50085 Part 2-2 (Clauses 10.5.103 and 10.5.104).

The floorboxes have been tested to and comply with the loading requirements of draft pr EN50085 Part 2-2 (Cable trunking systems and cable ducting systems for electrical installations Part 2-2: Particular requirements for cable trunking systems and cable ducting systems intended for mounting underfloor, flushfloor, or onfloor).

There are two loading criteria for the floorboxes - one with a point loading to replicate foot traffic for example, and the other, with a large plate to replicate fork trucks and heavier larger loads for example. For both loading criteria the maximum allowable deflection under load is 6mm and the maximum permanent deflection after the load has been removed is 3mm.

The Lid Deflection (loading) graph shows that the maximum point loading classification achieved is 3kN and the maximum large plate loading classification achieved is 5kN.

The Permanent Deflection graph shows the permanent deflection from the test wheel loading at 2kN is 0.3mm and large plate loading at 5kN is 0.4mm. This is well within the maximum allowable deflection of 3.0mm.

Note: This test data specifically refers to the 265x265mm sized floorbox frame assembly. The other floorbox sizes also comply with the required test criteria. Declarations of conformity are available on request for the entire range.

Cat 6 Compatibility

With the introduction of Cat 6 data cabling the orientation and depth of many data outlets has changed resulting in the need for greater backbox depths and wiring space to accommodate these longer data outlet. No longer is a 35mm wiring space sufficient to ensure data terminations can be made to the manufacturer's recommendations to prevent transmission losses. As a result MK has introduced 45mm wiring space for the Cablelink Plus Floorbox systems (as well as for the Prestige 3D wall trunking system). This easily accommodates the longer Cat 6 data outlets and leaves sufficient space for the data cable to run underneath it.

Lid Deflection – Cablelink Plus 265x265mm Frame Assembly

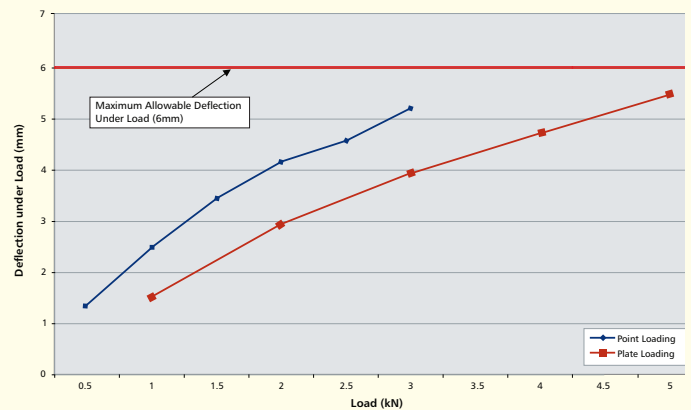

Permanent Deflection After Removal of Load – Cablelink Plus 265x265mm Frame

